



BEDS COLLECTION

saba

Index

Pixel

o6 Pixel Box Large

1o Pixel Box

16 Pixel Air

New York

22 New York Air

26 New York Box

Limes

29 Limes Large

3o Limes

32 Limes T Large

38 Avant-Après

48 Technical data

it — Abbiamo guardato i nostri progetti più belli da un'altra angolazione: quella del dormire. Ne abbiamo rispettato il linguaggio estetico e mantenuto le funzioni intelligenti che li contraddistinguono. La linea Pixel, morbida a tutti gli effetti, offre un unico volume arrotondato; i letti New York esibiscono la loro eleganza retrò con un'anima contemporanea. La collezione Limes, che a prima vista sembra un'isola galleggiante, invita ad andare oltre le convenzioni di spazio e forma predefinite ed infine il letto Avant-Après che grazie alle sue testiere mobili può assumere configurazioni sempre nuove.

en — We have looked at our most beautiful projects from another perspective: that of sleep. We have respected the visual language and maintained the intelligent functions that distinguishes them. The Pixel line that in its soft entirety offers a single comforting volume; the New York beds exhibit their retro elegance with a contemporary soul. The Limes collection, appears to be a floating flexible island, that initiates a conversation to go beyond predefined spaces and forms and finally the Avant-Après bed that can be constantly rearranged thanks to its movable headboards.

fr — Nous avons observé nos projets les plus beaux depuis une nouvelle perspective : celle du sommeil. Nous en avons respecté le langage esthétique et avons conservé les fonctions intelligentes qui les distinguent. La ligne Pixel, moelleuse à tous les égards, offre un volume arrondi unique ; les lits New York exhibent leur élégance rétro avec une âme contemporaine. La collection Limes, qui évoque à première vue une île flottante, invite à aller au-delà des conventions d'espace et de forme prédéfinies et le lit Avant-Après, grâce à ses têtes de lit mobiles, peut prendre des configurations constamment nouvelles.

es — Hemos observado nuestros mejores proyectos desde otra perspectiva: la del sueño. Hemos respetado el lenguaje estético y mantenido las funciones inteligentes que los caracterizan. La línea Pixel, suave a todos los efectos, ofrece un único volumen redondeado; las camas New York exhiben su elegancia retro con un espíritu contemporáneo. La colección Limes, que a primera vista parece una isla flotante, invita a ir más allá de las convenciones de espacio y forma. La cama Avant-Après con sus cabeceros móviles puede asumir diferentes configuraciones.

Design Sergio Bicego
Production year 2019

Technical data
p. 52



Pixel Box Large

Pixel Box

Letto 210x251 cm in tessuto
Sweet Velvet col. 144
tavolino Ring

Bed 210x251 cm in fabric
Sweet Velvet col. 144
Ring low table

Lit 210x251 cm en tissu
Sweet Velvet col. 144
table basse Ring

Cama 210x251 cm de tela
Sweet Velvet col. 144
mesa de centro Ring





it — Pixel Box Large è la proposta più voluminosa della collezione notte Pixel, completamente avvolto dal generoso e morbido giroletto. Il letto Pixel Box Large è la versione che più evidentemente richiama il divano Pixel e la sua iconica cucitura trapuntata.

en — Pixel Box Large is the most voluminous option in the Pixel bed collection, completely enclosed by the soft and ample bed frame. Pixel Box Large most evidently recalls the iconic and generous rounded shapes of Saba's Pixel sofa.

fr — Pixel Box Large est le modèle le plus volumineux de la collection nuit Pixel, entièrement entouré d'un tour de lit généreux et moelleux. Le lit Pixel Box Large est la version qui rappelle de la manière la plus évidente le canapé Pixel et sa couture matelassée emblématique.

es — Pixel Box Large es la propuesta más voluminosa de la colección noche Pixel, completamente envuelto por el generoso y suave cubre somier. La cama Pixel Box Large es la versión que más evidentemente evoca el sofá Pixel y su emblemática costura respunteada.

Letto 194x233 cm in tessuto
Sweet Velvet col. 144
poltrona Geo, tavolino Ring

Bed 194x233 cm in fabric
Sweet Velvet col. 144
Geo armchair, Ring low table

Lit 194x233 cm en tissu
Sweet Velvet col. 144
fauteuil Geo, table basse Ring

Cama 194x233 cm de tela
Sweet Velvet col. 144
sillón Geo, mesa de centro Ring





it — Pixel Box è un letto morbido a tutti gli effetti: accogliente al tatto, grazie alla generosa imbottitura della cornice in tessuto accoppiato a una ovatta di forte spessore e piacevole alla vista grazie ai suoi angoli arrotondati. Il giroletto e la testiera sono caratterizzati dalla particolare cucitura trapuntata che ricorda l'omonimo divano.

en — Pixel Box is soft in the entirety of its design. It offers a generous and comforting single volume thanks to the ample padding of the upholstered structure and rounded corners. The bed-frame and the headboard are characterised by the quilted seams that recall Saba's iconic Pixel sofa.

fr — Pixel box est un lit moelleux à tous les égards : accueillant au toucher, grâce au rembourrage généreux du cadre en tissu, associé à une forte épaisseur d'ouate, et agréable à regarder avec ses angles arrondis. Le tour et la tête de lit se distinguent par une couture matelassée particulière qui évoque le canapé homonyme.

es — Pixel Box es una cama suave a todos los efectos: acogedora al tacto gracias al generoso acolchado del marco de tela con fibra sintética espesa y agradable a la vista gracias a las esquinas redondeadas. El cubre somier y el cabecero tienen un acolchado cosido que recuerda al homónimo sofá.

Pixel Air



Letto 170x229 cm in pelle
Enchant col. 14 Seppia
tavolino Leyva, tavolino Ring,
consolle Hexa, pouf Geo

Bed 170x229 cm in leather
Enchant col. 14 Seppia
Leyva low table, Ring low table,
Hexa console, Geo pouf

Lit 170x229 cm en cuir
Enchant col. 14 Seppia
table basse Leyva, table basse
Ring, console Hexa, pouf Geo

Cama 170x229 cm de piel
Enchant col. 14 Seppia
mesa de centro Leyva, mesa de
centro Ring, consola Hexa, puf Geo





it — Pixel Air è la visione estetica leggera delle collezioni Pixel, caratterizzata da una base sollevata da terra da quattro piedini disponibili in due finiture. Il giroletto lineare ed essenziale, dona una nota di leggerezza alla testiera voluminosa che rimane costante nella linea e caratterizzata dalla cucitura trapuntata.

en — Pixel Air offers a lighter aesthetic to the Pixel collection, distinguished by being delicately rested on four feet available in two finishes. A linear and essential frame plays with the large and generous headboard that remains constant in the collection and is characterised by the quilted seams.

fr — Pixel Air incarne la vision esthétique légère de la collection Pixel, caractérisée par une base soulevée du sol par quatre pieds disponibles en deux finitions. Le tour de lit linéaire et essentiel donne une note de légèreté à la tête de lit volumineuse, commune à tous les modèles de la ligne et caractérisée par une couture matelassée.

es — Pixel Air es la visión estética ligera de la colección Pixel, caracterizada por una base levantada del suelo por cuatro pies disponibles en dos acabados. El cubre somier lineal y esencial da un toque de ligereza al cabecero voluminoso, que se mantiene constante en la línea y se caracteriza por la costura respunteada.

Design Sergio Bicego
Production year 2018

Technical data
p. 53



New York Air New York Box

it — Il letto New York Air segue la stessa linea stilistica dell'omonimo divano con la sua eleganza retrò unita ad un'anima contemporanea e a uno spirito senza tempo. Un letto dalla duplice identità, caratterizzato dalla forma esagonale e i dettagli trapuntati della testiera. New York Air poggia su un agile piedino a slitta, disponibile in diverse finiture.

en — The New York Air bed follows the same line of the sofa collection exhibiting all its retro elegance mixed with a contemporary soul and timeless spirit. A bed of two identities and characterised by the hexagonal shape and quilted detailing of the headboard, New York Air rests on an a sled base, available in various finishes.

fr — Le lit New York Air suit la même ligne stylistique que le canapé homonyme, avec son élégance rétro associée à une âme contemporaine et à un esprit intemporel. Un lit à l'identité double, caractérisé par la forme hexagonale et les détails matelassés de la tête de lit. New York Air repose sur un pied coulissant, disponible en différentes finitions.

es — La cama New York Air sigue la misma línea estilística del sofá homónimo, con su elegancia retro unida a un espíritu contemporáneo e intemporal. Una cama de doble identidad, caracterizada por la forma hexagonal y los detalles despunteados del cabecero. New York Air se apoya sobre un ágil pie corredero, disponible en distintos acabados.

Letto 203x225 cm in tessuto
Lario col. 58
poltrona Amélie, tavolini Più,
tavolino Ring

Bed 203x225 cm in fabric
Lario col. 58
Amélie armchair, Più low tables,
Ring low table

Lit 203x225 cm en tissu
Lario col. 58
fauteuil Amélie, tables basses Più,
table basse Ring

Cama 203x229 cm de tela
Lario col. 58
sillón Amélie, mesas de centro Più,
mesa de centro Ring



it — La variante con giroletto a terra offre un'opzione più generosa ed esprime l'identità classica del modello New York, mantenendo l'iconica testata con trapuntatura.

en — The variation with a floor bed frame offers a fuller option and expresses the classic identity of the New York line, maintaining the iconic quilted headrest.



fr — La variante avec tour de lit au sol offre une version plus généreuse et exprime l'identité classique du modèle New York, tout en conservant l'emblématique tête de lit matelassée.

es — La variante con cubre somier de suelo ofrece una opción más generosa y expresa la identidad clásica del modelo New York manteniendo el emblemático cabecero con pespunteado.

Letto 203x225 cm in tessuto
Lario col. 58
pouf Island, tavolino Più,
tavolino Leyva

Bed 203x225 cm in fabric
Lario col. 58
Island pouf, Più low table,
Leyva low table

Lit 203x225 cm en tissu
Lario col. 58
pouf Island, table basse Più,
table basse Leyva

Cama 203x229 cm de tela
Lario col. 58
puf Island, mesa de centro Più,
mesa de centro Leyva



Limes Large
Limes
Limes T Large

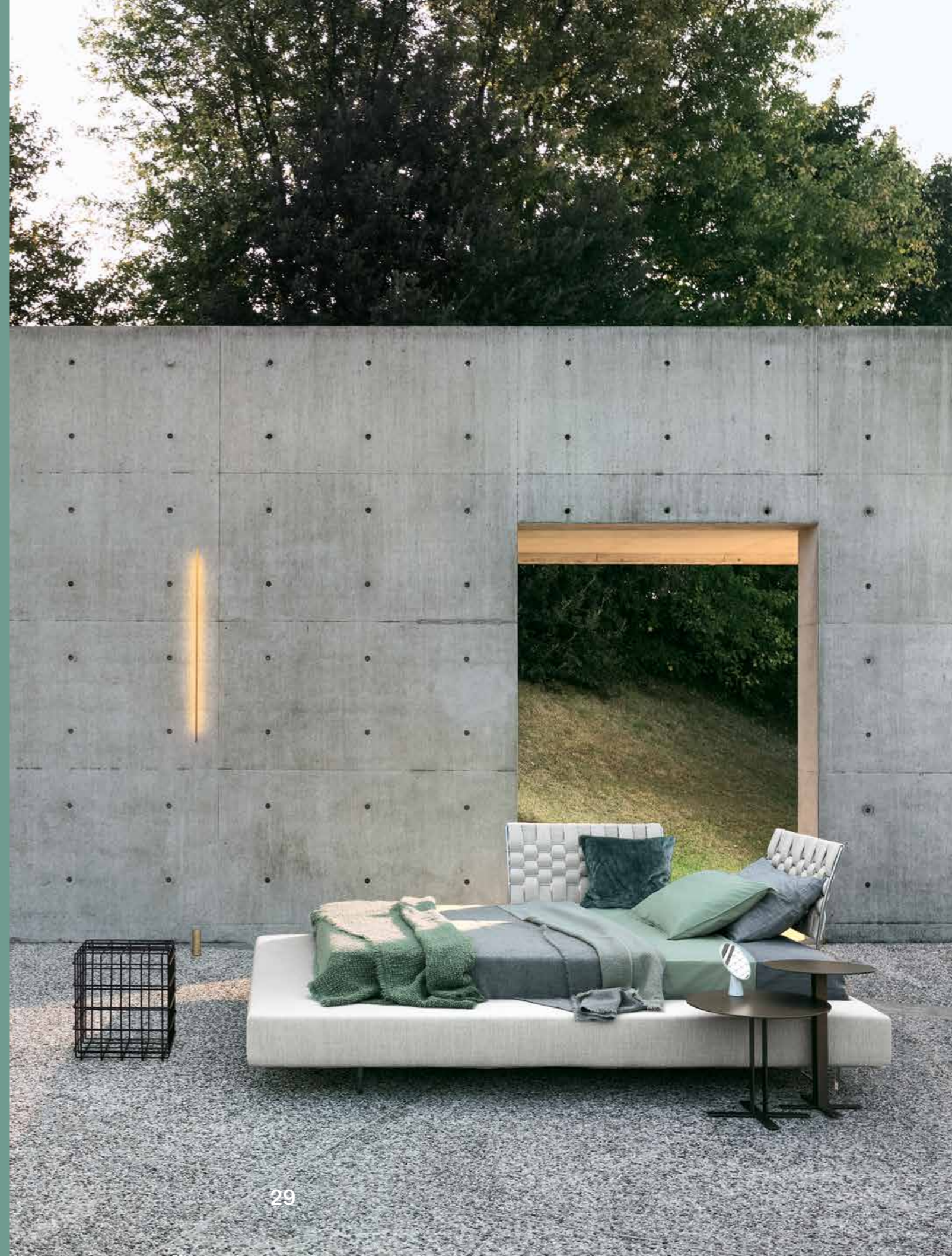

it — Il letto Limes mantiene l'intelligente funzionalità che caratterizza l'omonimo divano adattata alla zona notte. Un'isola leggera appare sospesa su sezioni rettangolari in metacrilato trasparente di 14 cm. Limes può essere completamente riconfigurato spostando le testiere in metallo lungo tutto il perimetro del materasso.

en — The Limes bed maintains the intelligent functionality that characterises the sofa line but has been adapted for a different interior area and function. The lightweight mobile island appears to be floating on its 14cm rectangular transparent legs. It can become something else by simply adjusting the position of the two metal headboards that can be placed anywhere along mattress's entire perimeter.

fr — Le lit Limes conserve l'intelligente fonctionnalité qui caractérise le canapé homonyme, adaptée à l'espace nuit. Une île légère apparaît suspendue sur des sections rectangulaires en méthacrylate transparent de 14 cm. Le lit Limes peut être complètement reconfiguré en déplaçant les têtes de lit en métal sur tout le pourtour du matelas.

es — La cama Limes mantiene la inteligente funcionalidad que caracteriza el sofá homónimo adaptándola a la zona noche. Una isla ligera suspendida sobre secciones rectangulares de metacrilato transparente de 14 cm. Limes se puede reconfigurar completamente desplazando los cabeceros de metal a lo largo de todo el perímetro del colchón.

Letto 174x215 cm in tessuto
Avant Après col. 18
tavolino Più, tavolino Ring

Bed 174x215 cm in fabric
Avant Après col. 18
Più low table, Ring low table

Lit 174x215 cm en tissu
Avant Après col. 18
table basse Più, table basse Ring

Cama 174x215 cm de tela
Avant Après col. 18
mesa de centro Più,
mesa de centro Ring

Letto 174x240 cm in tessuto
Avant Après col. 18
pouf Geo

Bed 174x240 cm in fabric
Avant Après col. 18
Geo pouf

Lit 174x240 cm en tissu
Avant Après col. 18
pouf Geo

Cama 174x240 cm de tela
Avant Après col. 18
puf Geo



it — Limes T Large segue la stessa linea stilistica della collezione Limes ed è caratterizzato da una funzionale mensola integrata imbottita, che a seconda del posizionamento dei pannelli può aggiungere un'area extra alla testiera o alla pediera.

en — Limes T Large follows the same stylistic line of the Limes collection and is characterized by a functional integrated padded shelf, which depending on the panels positioning, can add an extra area to the headboard or footboard.

fr — Limes T Large suit la même ligne stylistique que la collection Limes et se caractérise par une étagère intégrée rembourrée très fonctionnelle qui, selon la position des panneaux, peut ajouter un espace supplémentaire à la tête ou au pied de lit.

es — Limes T Large sigue la misma línea estilística de la colección Limes y se caracteriza por una repisa funcional integrada y tapizada, que según la posición de los paneles puede añadir un área adicional al cabecero o al piecero.

Letto 174x240 cm in tessuto
Avant Après col. 18
pouf Geo

Bed 174x240 cm in fabric
Avant Après col. 18
Geo pouf

Lit 174x240 cm en tissu
Avant Après col. 18
pouf Geo

Cama 174x240 cm de tela
Avant Après col. 18
puf Geo





Avant-Après



Letto 162x214 cm in tessuto
 Avant Après col. 17
 tavolini Più, tavolino Ring, tavolino
 Leyva, pouf Geo

Bed 162x214 cm in fabric
 Avant Après col. 17
 Più low tables, Ring low table,
 Leyva low table, Geo pouf

Lit 162x214 cm en tissu
 Avant Après col. 17
 tables basses Più, table basse Ring,
 table basse Leyva, pouf Geo

Cama 162x214 cm de tela
 Avant Après col. 17
 mesas de centro Più, mesa de
 centro Ring, mesa de centro Leyva,
 puf Geo

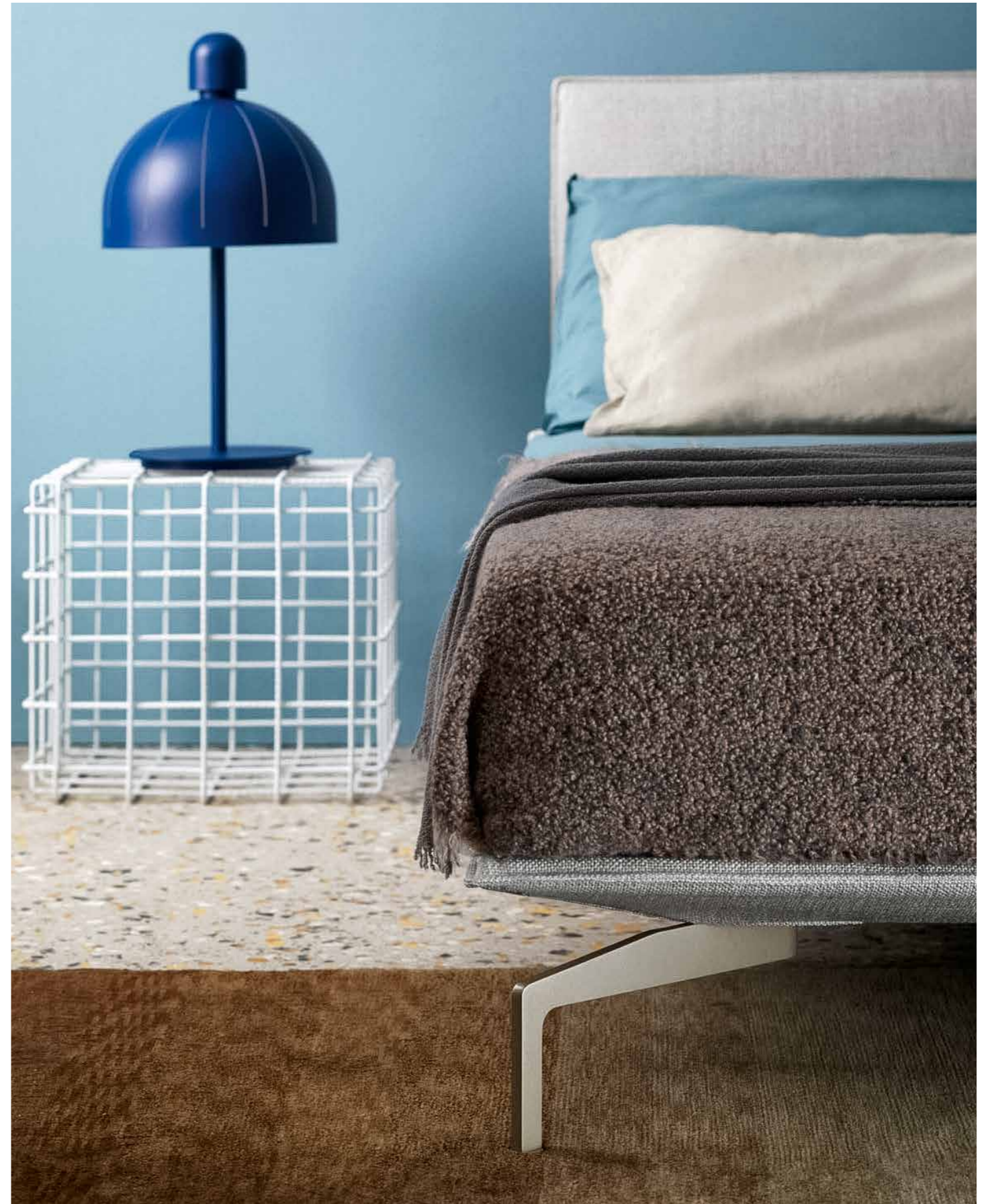



it — Avant-Après ha un'allure sobria e un tratto elegante. Rigoroso eppur leggero, assume configurazioni estremamente interessanti grazie alla particolare testiera che può essere posizionata lungo il perimetro della base. Il giroletto poggia su una base di metallo rivestita in tessuto o in pelle, sollevata da terra su piedini in metallo verniciato.

en — The Avant-Après bed has a sober allure and an elegant presence. Grounded yet lightweight, it transforms into extremely interesting configurations thanks to the particular headboards that can be positioned along the bases's perimeter. The bed-frame, available for upholstery in fabric or leather, rests neatly on a metal base finished with painted metal feet.

fr — Le modèle Avant-Après possède une allure sobre et une ligne élégante. Rigoureux tout en étant léger, il prend des configurations extrêmement intéressantes grâce à la tête de lit particulière qui peut être positionnée sur tout le pourtour de la base. Le tour de lit repose sur une base en métal revêtue de tissu ou de cuir, soulevée du sol par des pieds en métal laqué.

es — Avant-Après tiene un aspecto sobrio y un rasgo elegante. Riguroso y, sin embargo, ligero, asume configuraciones extremadamente interesantes gracias al particular cabecero, que puede colocarse a lo largo del perímetro de la base. El cubre somier se apoya sobre una base de metal revestida de tejido o de piel, levantada del suelo sobre pies de metal pintado.





Technical data



1
it — **Posizione 1:** nella prima posizione il meccanismo porta la rete obliqua e permette un comodo accesso al box contenitore (figura 1).

en — **Position 1:** in position 1 the mechanism puts the slatted base obliquely and allows an easy access to the box container (picture 1).

fr — **Position 1:** dans la première position le mécanisme met le sommier à lattes obliquement et permet un accès confortable à la boîte de rangement (image 1).

es — **Posición 1:** en la primera posición el mecanismo pone el somier con tablas oblicuamente y permite un cómodo acceso a la caja de almacenamiento (imagen 1).



2
it — **Posizione 2:** dalla posizione 1 con un semplice scatto, la rete si posiziona orizzontalmente al pavimento, permettendo di lavorare sul materasso con una postura verticale (figura 2). Non sporgendo frontalmente dalla pediera, l'ingombro della rete rimane sempre all'interno delle dimensioni del letto (figura 3).

en — **Position 2:** from position 1, the slatted base is positioned horizontally to the floor by a simple click, allowing to operate on the mattress with a vertical posture (picture 2). As the slatted base does not stick out of the foot bed, the slatted base footprint remains within the bed dimensions (picture 3).



3
fr — **Position 2:** à partir de la position 1, par un simple mouvement, le sommier se place horizontalement au sol, en permettant de travailler sur le matelas avec une posture verticale (image 2). Comme le sommier ne sort pas du pied de lit, l'encombrement du sommier reste toujours à l'intérieur des dimensions du lit.

es — **Posición 2:** a partir de la posición 1, por medio de un simple movimiento, el somier se posiciona horizontalmente al suelo, permitiendo de trabajar sobre el colchón en postura vertical. (imagen 2). Como el somier no sobresale del pie de cama, el envoltorio del somier queda siempre dentro de las dimensiones de la cama (imagen 3).



4
it — **Angolari:** gli angolari di supporto delle reti permettono, in assenza del meccanismo di sollevamento, di essere regolati in 6 differenti altezze a discrezione del cliente (figura 4). In presenza del meccanismo, è consentita un'unica posizione degli angolari (figura 5).

en — **Angle irons:** in the absence of the lifting mechanism, the support angle irons of the bed bases can be adjusted in 6 different heights at the user's discretion (picture 4). In presence of mechanism, only one angle irons position is allowed (picture 5).



5
fr — **Cornières:** les cornières de support des sommiers permettent en l'absence de mécanisme de levage de les régler en 6 différents hauteurs à la discrétion du client (image 4). En présence de mécanisme, on peut avoir une unique position des cornières de support (image 5).

es — **Perfiles metálicos en forma de L:** los perfiles metálicos en forma de L de apoyo a los somiers permiten a falta de mecanismo de levantamiento de regularlos en 6 diferentes alturas a elección del cliente (imagen 4). En presencia de mecanismo, está permitida una única posición de los perfiles metálicos (imagen 5).

Pixel Box Large

design Sergio Bicego

p. 4



Misura rete / Size for Bed base / 160x200 cm

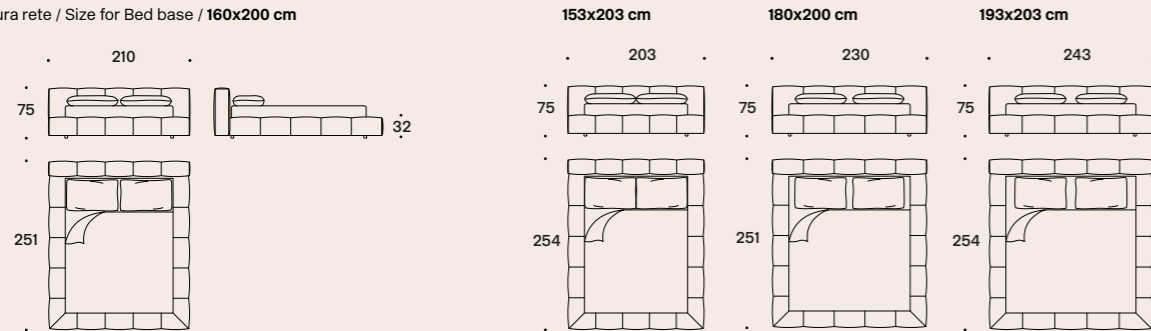

New York Air

design Sergio Bicego

p. 20



Misura rete / Size for Bed base / 160x200 cm

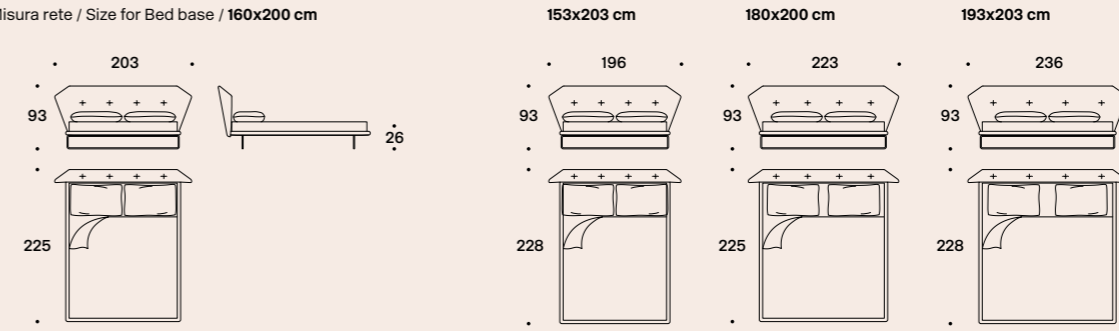

Pixel Box

design Sergio Bicego

p. 10



Misura rete / Size for Bed base / 160x200 cm

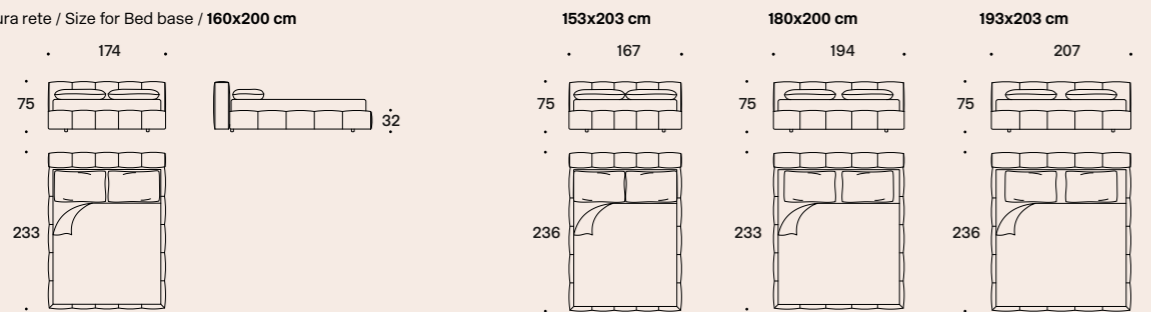

New York Box

design Sergio Bicego

p. 26



Misura rete / Size for Bed base / 160x200 cm

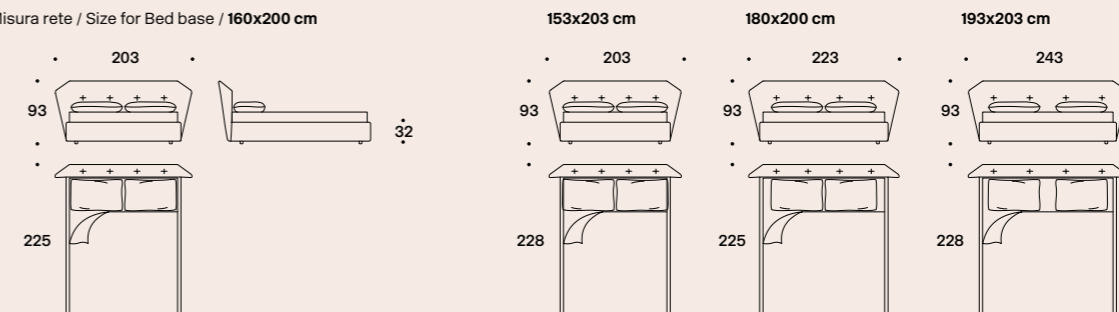

Pixel Air

design Sergio Bicego

p. 15



Misura rete / Size for Bed base / 160x200 cm

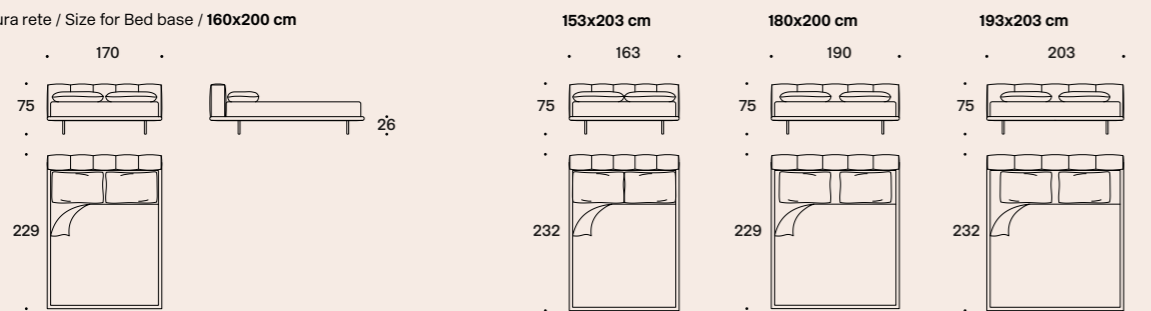

Limes

design Sergio Bicego

p. 30



Misura rete / Size for Bed base / 160x200 cm

Testiera / Headboard
Fasce imbottite / Padded bands

Testiera / Headboard
Tessuto trapuntato / Quilted fabric

Fianco con testiera tessuto trapuntato /
Side with quilted fabric headboard

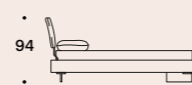
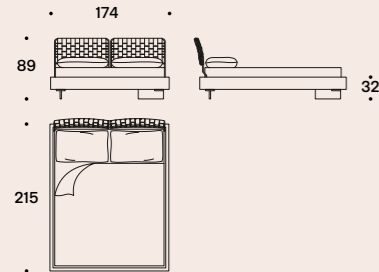

Esempi posizione pannelli testiera / Examples headboard panels position

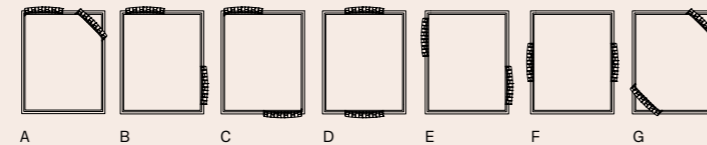

Limes

design Sergio Bicego

p. 30



Misura rete / Size for Bed base / 153x203 cm

Testiera / Headboard
Fasce imbottite / Padded bands

Testiera / Headboard
Tessuto trapuntato / Quilted fabric

Fianco con testiera tessuto trapuntato /
Side with quilted fabric headboard

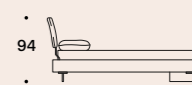
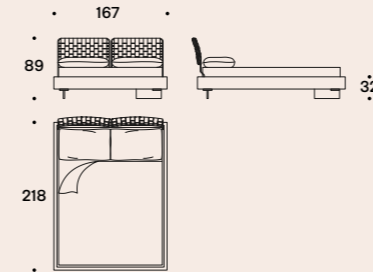

Esempi posizione pannelli testiera / Examples headboard panels position

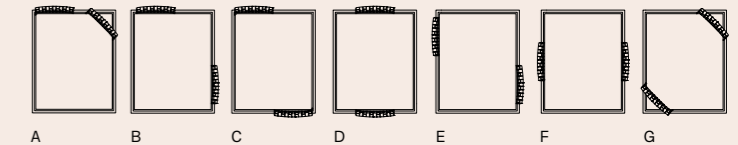

Limes T Large

design Sergio Bicego

p. 32



Misura rete / Size for Bed base / 160x200 cm

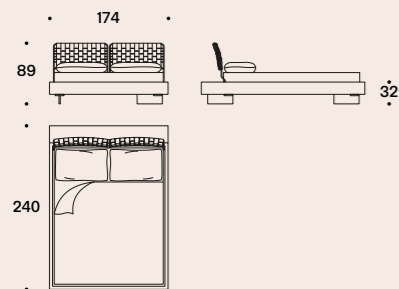

Versione sponda singola — Testiera /
Single sideboard version — Headboard

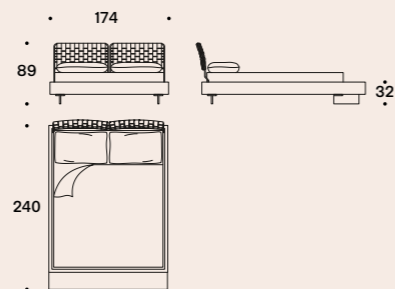

Versione sponda singola — Pediera /
Single sideboard version — Footboard

Limes T Large

design Sergio Bicego

p.32



Misura rete / Size for Bed base / 153x203 cm

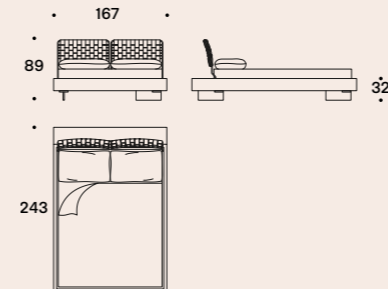

Versione sponda singola — Testiera /
Single sideboard version — Headboard

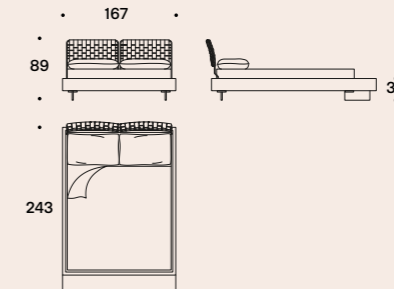

Versione sponda singola — Pediera /
Single sideboard version — Footboard

Limes Large

design Sergio Bicego

p. 29



Misura rete / Size for Bed base / 160x200 cm

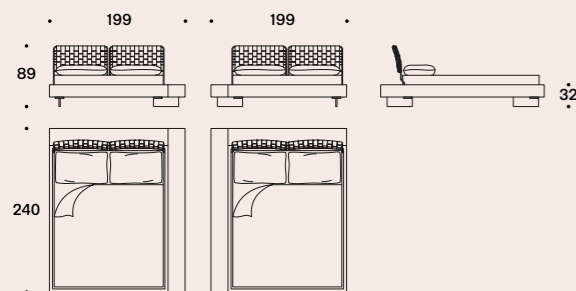

1 A 2 A
Sponda doppia angolare — versione 1 A & 2 A /
Corner double sideboard — 1 A & 2 A version

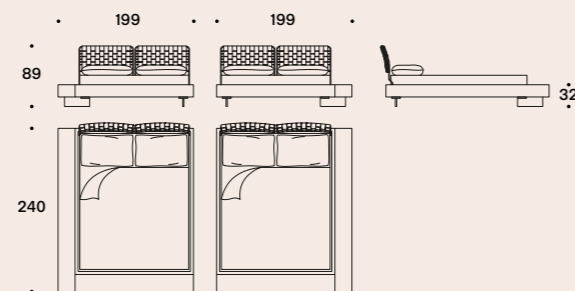

1 B 2 B
Sponda doppia angolare — versione 1 B & 2 B /
Corner double sideboard — 1 B & 2 B version

Limes Large

design Sergio Bicego

p. 29



Misura rete / Size for Bed base / 153x203 cm

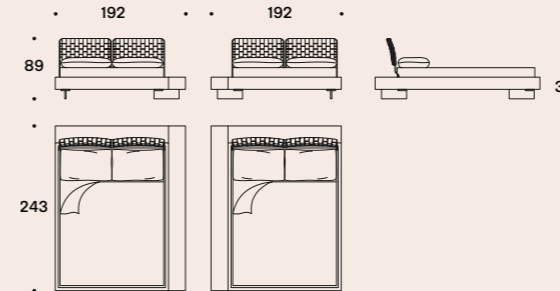

1 A 2 A
Sponda doppia angolare — versione 1 A & 2 A /
Corner double sideboard — 1 A & 2 A version

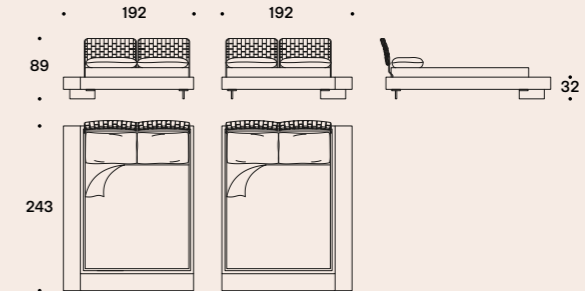

1 B 2 B
Sponda doppia angolare — versione 1 B & 2 B /
Corner double sideboard — 1 B & 2 B version

Limes design Sergio Bicego p. 30



Misura rete / Size for Bed base / 180x200 cm

Testiera / Headboard
Fasce imbottite / Padded bands

Testiera / Headboard
Tessuto trapuntato / Quilted fabric

Fianco con testiera tessuto trapuntato /
Side with quilted fabric headboard

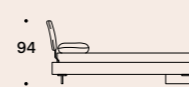
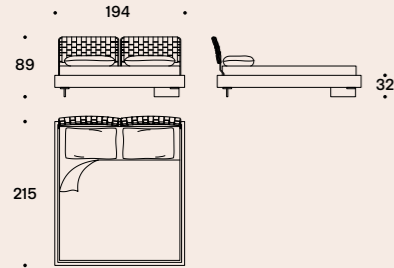

Esempi posizione pannelli testiera / Examples headboard panels position

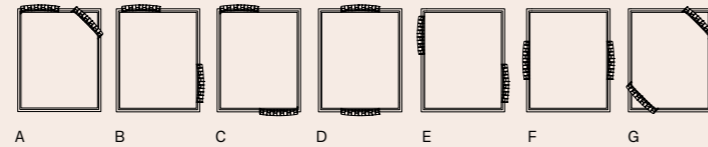

Limes T Large design Sergio Bicego p. 32



Misura rete / Size for Bed base / 180x200 cm

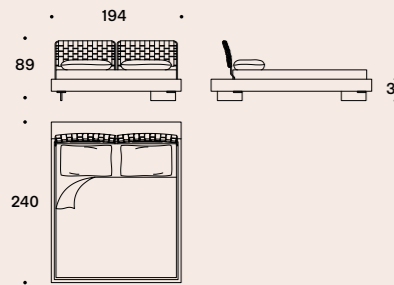

Versione sponda singola — Testiera /
Single sideboard version — Headboard

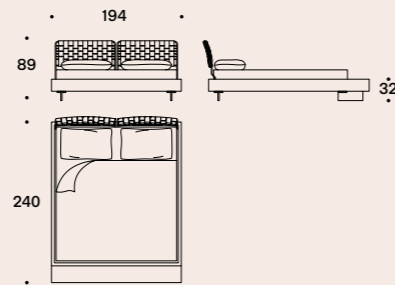

Versione sponda singola — Pediera /
Single sideboard version — Footboard

Limes Large design Sergio Bicego p. 29



Misura rete / Size for Bed base / 180x200 cm

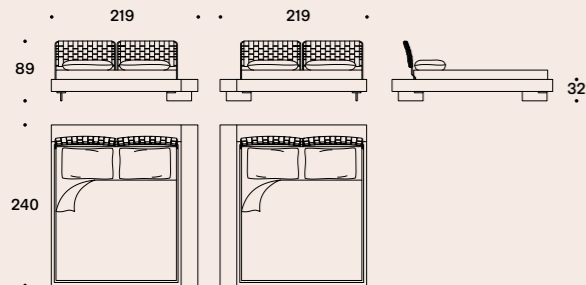

1 A 2 A
Sponda doppia angolare — versione 1 A & 2 A /
Corner double sideboard — 1 A & 2 A version

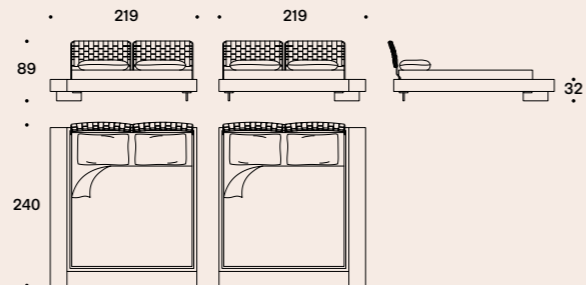

1 B 2 B
Sponda doppia angolare — versione 1 B & 2 B /
Corner double sideboard — 1 B & 2 B version

Limes design Sergio Bicego p. 30



Misura rete / Size for Bed base / 193x203 wcm

Testiera / Headboard
Fasce imbottite / Padded bands

Testiera / Headboard
Tessuto trapuntato / Quilted fabric

Fianco con testiera tessuto trapuntato /
Side with quilted fabric headboard

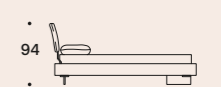
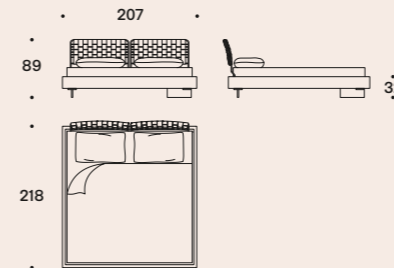

Esempi posizione pannelli testiera / Examples headboard panels position

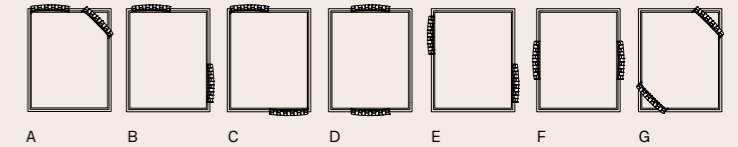

Limes T Large design Sergio Bicego p. 32



Misura rete / Size for Bed base / 193x203 cm

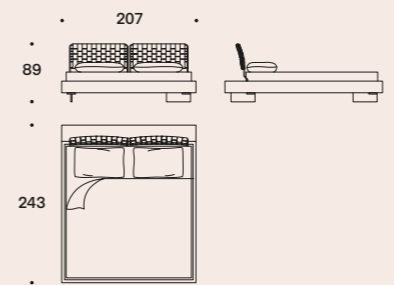

Versione sponda singola — Testiera /
Single sideboard version — Headboard

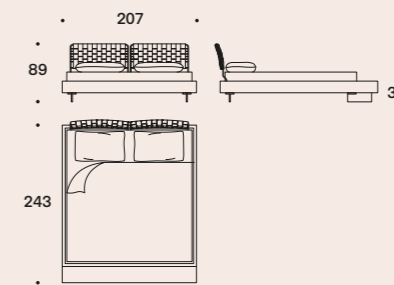

Versione sponda singola — Pediera /
Single sideboard version — Footboard

Limes Large design Sergio Bicego p. 29



Misura rete / Size for Bed base / 193x203 cm

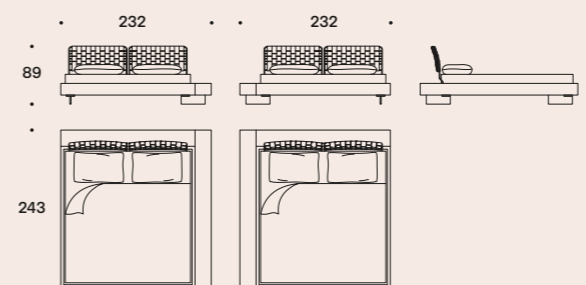

1 A 2 A
Sponda doppia angolare — versione 1 A & 2 A /
Corner double sideboard — 1 A & 2 A version

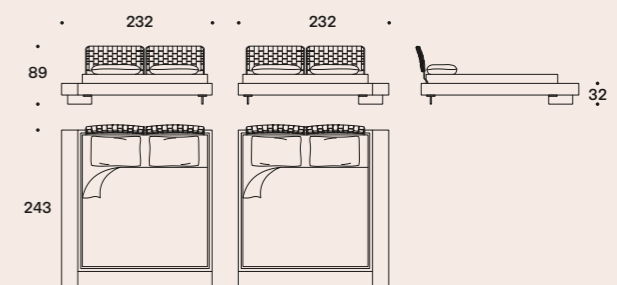

1 B 2 B
Sponda doppia angolare — versione 1 B & 2 B /
Corner double sideboard — 1 B & 2 B version



Misura rete / Size for Bed base / 160x200 cm

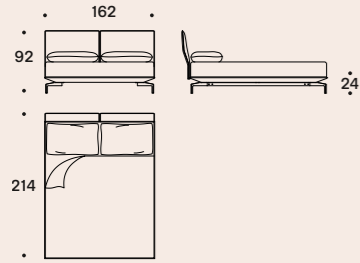

153x203 cm

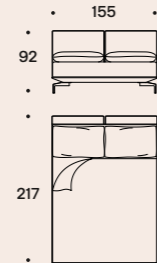

180x200 cm

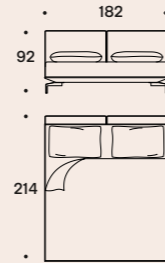

193x203 cm

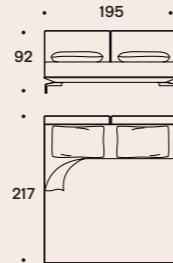

Esempi posizione pannelli testiera / Examples headboard panels position

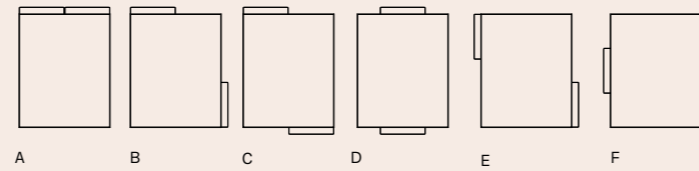

Geo armchair

design Paolo Grasselli

p. 11



Poltrona / Armchair

Finitura struttura / Frame finish

- 1 Ottone / Brass / Laiton / Latón
- 2 Rame / Copper / Cuivre / Cobre
- 3 Grigio / Grey / Gris / Gris

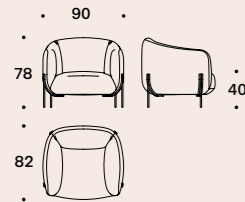

Amélie

design Sergio Bicego

p. 23



Poltrona / Armchair

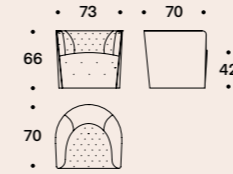

Geo pouf

design Paolo Grasselli

p. 34



Poufs

Poufs con telaio / Poufs with frame

Finitura struttura / Frame finish

- 1 Ottone / Brass / Laiton / Latón
- 2 Rame / Copper / Cuivre / Cobre
- 3 Grigio / Grey / Gris / Gris

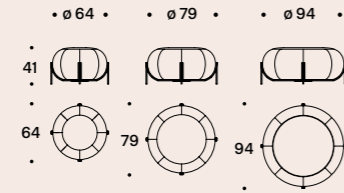
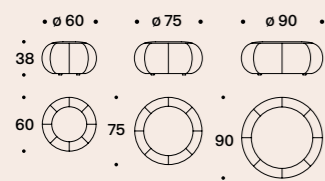

Island pouf

design Serena Confalonieri

p. 26

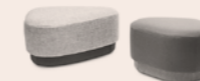

Poufs

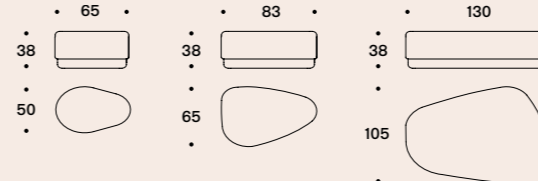

Ring design Serena Confalonieri p. 4, 20, 30, 37



Tavolini / Low tables

Finitura struttura / Structure finish

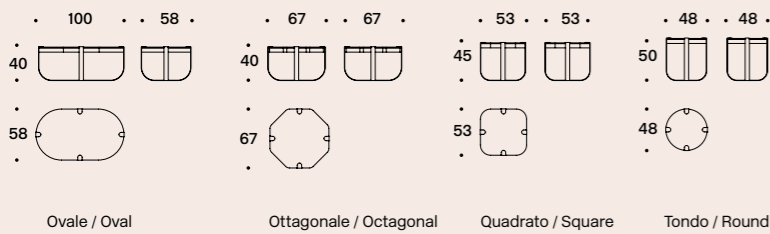

- 1 Cromo / Chrome / Chrome / Cromo
- 2 Ottone / Brass / Liton / Latón
- 3 Black nichel / Black nickel / Nickel noir / Níquel negro
- 4 Rame / Copper / Cuivre / Cobre

Più Table design Giuseppe Viganò p. 23, 41



Tavolini / Low tables

Finitura opaca piani e struttura / Matt table top and structure finish

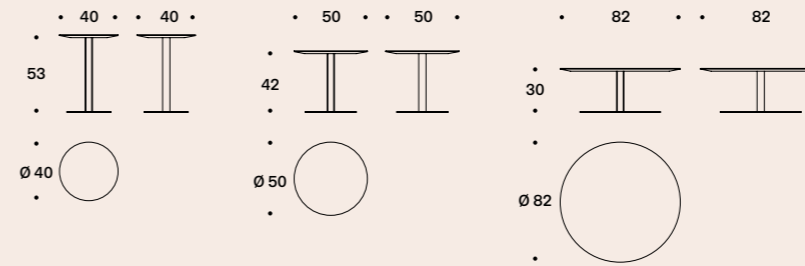

- 1 Bianco / White / Blanc / Blanco
- 2 Rosso / Red / Rouge / Rojo
- 3 Nero / Black / Noir / Negro
- 4 Bronzo / Bronze / Bronze / Bronce
- 5 Argento / Silver / Argent / Plata

Leyva design Giuseppe Viganò p. 17, 27

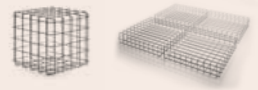

Tavolini / Low tables

Finitura struttura / Frame finish

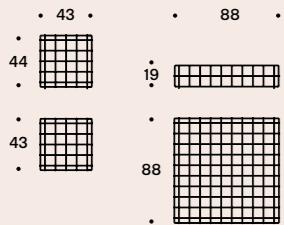

- 1 Bianco / White / Blanc / Bianco
- 2 Nero / Black / Noir / Negro

Hexa design Enzo Berti p. 17



Top tondi / Round top

Top ovale / Oval top

Consolle

Finitura struttura / Structure finish

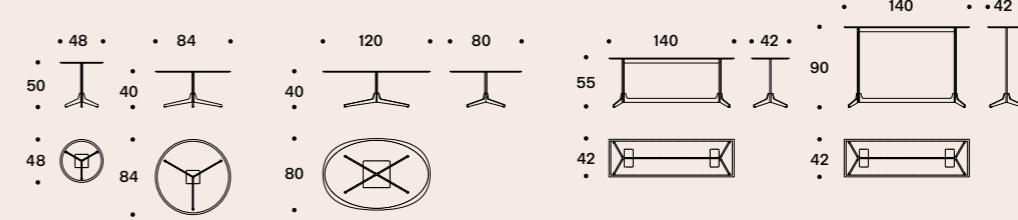

- 1 Bronzo / Bronze / Bronze / Bronce
- 2 Bruno oliva / Brown olive / Brun olive / Marrón oliva

Finitura top marmo / Top marble finish

- 1 Bianco Carrara / White Carrara / Blanc Carrara / Blanco Carrara
- 2 Noir Antique
- 3 Emperador Dark

Saba Italia

35018 S. Martino di Lupari
Padova / Italy
via dell'Industria, 17
T +39 049 946 2227
F +39 049 946 2219
infosaba@sabaitalia.it
www.sabaitalia.it

Project managers
Alessandra Santi
Amelia Pegorin

Art direction
Studio MILO
Photography
Beppe Brancato
Claudio Rocci

Graphic Design
Designwork

Text translation
Isabel Migliore
PSG Translations

Thanks to:
Cc-tapis
Society Limonta
Salvatori
Sonia Pedrazzini
Residenza Location
Nahoor
Davide Groppi
Federica Biasi
Masiero
MM Lampadari
Mason Editions
Manfredi Style

Paper
Arcoprint EW
300 gr, Artic Volume
White 130 gr

Fonts in New Rail
Alphabet:
New Rail Alphabet
Light
New Rail Alphabet
Medium
Nw Alphabet Bold

Made and printed
Italy,
October 2019
by Grafiche Antiga

