

LC

---

Collection

---

Taco

Twirl

Borgo

Idda

+4

laCividina



---

# Collection

---

Taco

CHAIR

---

Twirl

ARMCHAIR

---

Borgo

COFFEE TABLE

---

Idda

COFFEE TABLE

---

TACO

**TACO** cod. 1400  
Chair



# Taco

|                 |  |
|-----------------|--|
| <b>Family</b>   | Chair  |
| <b>Designer</b> | Alessandro Stabile / 2022                                    |
| <b>Link</b>     | <a href="http://www.read-mo.re/taco">www.read-mo.re/taco</a> |

**IT** Taco è la poltroncina che smaterializza e rende leggero l'imbottito, sottraendone la tradizionale struttura in legno e poliuretano espanso. Composta solamente da due strati di feltro naturale e una sottilissima anima di acciaio armonico, la scocca viene lavorata in piano per poi assumere tridimensionalità una volta piegata sul telaio, che ne tiene uniti i lembi tramite precise fresature. In modo naturale, forme morbide e nette trovano il proprio equilibrio, creando un design ergonomico e trasversale all'utilizzo residenziale e contract.

## EN

The Taco soft chair dissipates padding and makes it lighter, stripping away the traditional wooden and polyurethane foam structure. Consisting solely of two layers of natural felt and a very slender spring steel core, the body is flat when it is produced and it is given a three-dimensional form when it is folded onto the frame, which holds the edges together thanks to precision milling. A natural balance is struck between soft and clean-cut forms, in a versatile, ergonomic design that is suitable for both the home and contract markets.

## FR

Taco est le petit fauteuil qui dématérialise le rembourrage et le rend léger, en le débarrassant de la structure traditionnelle en bois et en mousse de polyuréthane. Composée uniquement de deux couches de feutre naturel et d'une âme ultra-fine en acier à ressorts, la coque est façonnée à plat pour prendre ensuite une forme tridimensionnelle une fois pliée sur le cadre, qui maintient les bords solidaires grâce à un fraisage de précision. De manière naturelle, les formes douces et épurées trouvent leur équilibre, créant un design ergonomique qui s'applique aussi bien à un usage résidentiel qu'à un usage professionnel.

## DE

Taco ist ein kleiner Sessel, der die Polsterung vom Stofflichen befreit und somit „erleichtert“, indem er auf die traditionelle Struktur aus Holz und Polyurethanschaum verzichtet. Die Schale besteht lediglich aus zwei Lagen Naturfilz und einem hauchdünnen Kern aus harmonischem Stahl, ist flach gearbeitet und wird erst dreidimensional, wenn sie auf den Rahmen gespannt wird, der die Kanten in präzisen Fräsungen zusammenhält. Die weichen, klaren Formen finden ihr natürliches Gleichgewicht und lassen ein ergonomisches Design entstehen, das im Wohn- und Contractbereich in vielseitiger Weise eingesetzt werden kann.

**TACO** cod. 1400  
Chair /  
**BORGIO** cod. 1430  
Coffee table



CHAIR



COLLECTION

TACO

TACO cod. 1400  
Chair /  
BORGIO cod. 1430  
Coffee table

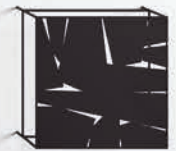



CHAIR



**TACO** cod. 1400  
Chair

TACO

**TACO** cod. 1400  
Chair



CHAIR

Dati tecnici · Technical data · Données techniques · Technische Angaben

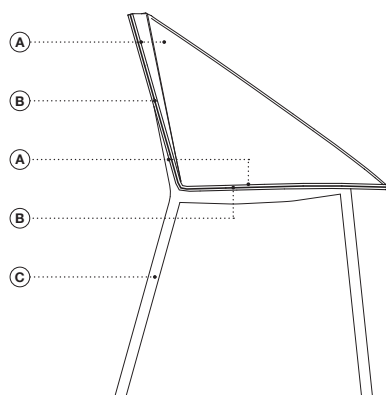

A. Rivestimento fisso in feltro  
B. Metallo  
C. Acciaio

A. Revêtement pas déhoussable en feutre  
B. Métal  
C. Acier

A. Fixed upholstery in felt  
B. Metal  
C. Steel

A. Unabziehbarer Bezug aus Filz  
B. Metall  
C. Stahl

Caratteristiche · Features · Caractéristiques · Eigenheiten

- Telaio rinforzato per uso aree pubbliche
- Poliuretano espanso ignifugo
- Poliuretano espanso indeformabile a quote differenziate ad alta densità
- Cuciture rinforzate con supporto in fibra di carbonio
- Basi personalizzabili con colore su richiesta del cliente

- Reinforced frame for public area use
- Flame-retardant polyurethane foam
- Undeformable polyurethane foam of different densities
- Reinforced stitching with carbon fiber support
- Bases customizable with other colors on customer's request

- Structure renforcée pour une utilisation en espace public
- Mousse polyuréthane expansé ignifuge
- Mousse polyuréthane expansé indéformable à épaisseurs différenciées
- Coutures renforcées de fibre de carbone
- Piètements disponibles en autres finitions sur demande

- Verstärkte Holzstruktur für Nutzung bei öffentlichem Bereich
- Feuerfester Polyurethanschaum
- Formbeständige Polyurethanschaum unterschiedlicher Dichte
- Verstärkte Säume mit Stütz aus Kohlefaser
- Gestell in Kundenfarben auf Anfrage verfügbar

Coordinati · Matching items · Produits assortis · Abgestimmte Produkte



NODE+



TURI TURI



MIL



SCANCARÒ

Finiture in metallo · Metal finishes · Finitions métal · Metallausführungen



Avorio  
Ivory  
Ivoire  
Elfenbein



Nero pece  
Pitch black  
Poix noir  
Pech Schwarz

cod. 1400 / chair



62 cm  
24 3/8"



58 cm  
22 7/8"

TWIRL

TWIRL cod. 1411  
Armchair



# Twirl

|                 |  |
|-----------------|--|
| <b>Family</b>   | Armchair   |
| <b>Designer</b> | Gordon Guillaumier / 2022                                      |
| <b>Link</b>     | <a href="http://www.read-mo.re/twirl">www.read-mo.re/twirl</a> |

**IT** Con un vortice irregolare e sottile, Twirl sintetizza in un unico divanetto gli elementi di seduta, scrittoio e schermatura. Il piccolo piano d'appoggio, dotato di prese elettriche e USB, dà origine alla spirale che diventa al tempo stesso schienale e paravento, offrendo il comfort visivo e acustico ideale per lavorare anche in ambienti open space. Una nicchia privata resa ancora più accogliente dai volumi generosi della seduta e dall'inedito utilizzo di materiali morbidi e flessibili, sostenuti da un'impercettibile struttura in legno.

## EN

The Twirl single sofa combines the features of a seat, a desk and a screen in one slender, swirling shape. The little support surface equipped with electrical and USB sockets is the starting point for a spiral that serves as both a backrest and a partition, providing ideal visual and acoustic comfort for people to work anywhere, including in open-plan environments. The private alcove is made even more welcoming by the generous size of the seat and the original use of soft, flexible materials that are supported by an imperceptible wooden framework.

## FR

Avec sa forme tourbillonnante irrégulière et légère, Twirl réunit les fonctions de siège, de bureau et de cloison en un seul petit canapé. Du petit plan d'appui, équipé de prises électriques et USB, se déploie la spirale qui fait office à la fois de dossier et de paravent, offrant un confort visuel et acoustique idéal pour travailler n'importe où, y compris en open space. Cette alcôve privée est rendue encore plus accueillante par les volumes généreux du siège et l'utilisation inédite de matériaux doux et souples, soutenus par une structure en bois imperceptible.

## DE

Wie ein unregelmäßiger, graziler Strudel formt Twirl die Elemente eines Sitzmöbels, Schreibpults und eines Wandschirms und vereint sie in einem einmaligen, alkoventartigen Sofa. Aus der kleinen Ablage, die mit Steckdosen und USB-Buchsen ausgestattet ist, entwickelt sich eine Spirale, die gleichzeitig als Rückenlehne und Abschirmung dient und auch im offenen Ambiente einen idealen visuellen und akustischen Arbeitskomfort bietet. Eine Nische, die zum Rückzug einlädt und durch die großzügig bemessene Sitzfläche und die verwendeten weichen und flexiblen Materialien, getragen von einer unsichtbaren Holzstruktur, noch gemütlicher wird.

TWIRL

**TWIRL** cod. 1411  
Armchair /  
**TWIRL** cod. 1412  
Armchair /  
**IDDA** cod. 1421  
Coffee table



ARMCHAIR



TWIRL

**TWIRL** cod. 1411  
Armchair /  
**TWIRL** cod. 1412  
Armchair /  
**SCANCARÒ** cod. 8831  
Coffee table /  
**SCANCARÒ** cod. 8834  
Coffee table





ARMCHAIR



COLLECTION

TWIRL

**TWIRL** cod. 1411  
Armchair



Dati tecnici · Technical data · Données techniques · Technische Angaben

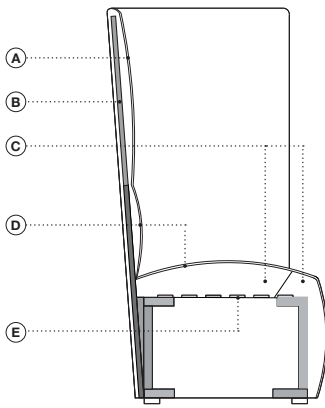

- Legno massiccio faggio
- Multistrato di faggio
- A.** Rivestimento
- B.** Polipropilene
- C.** Poliuretano espanso ignifugo a quote differenziate
- D.** Fibra di poliestere
- E.** Cinghie elastiche ad alta densità

- Solid beech
- Multilayered beech
- A.** Upholstery
- B.** Polypropylene
- C.** Flame-retardant undeformable polyurethane foam of different densities
- D.** Polyester fibers
- E.** High density elastic straps

- Bois de hêtre massif
- Multiplis de hêtre
- A.** Revêtement
- B.** Polypropylène
- C.** Mousse polyuréthane expansé ignifuge indéformable à épaisseurs différenciées
- D.** Fibre de polyester
- E.** Sangles élastiques

- Massiveholz Buche
- Buchenschinchholz
- A.** Bezug
- B.** Polypropylen
- C.** Polyurethanschaum Feuerfester formbeständige in unterschiedlicher Dichte
- D.** Polyester
- E.** Elastischen Gurtbändern

Caratteristiche · Features · Caractéristiques · Eigenheiten

- Telaio rinforzato per uso aree pubbliche
- Poliuretano espanso ignifugo
- Poliuretano espanso indeformabile a quote differenziate ad alta densità
- Cuciture rinforzate con supporto in fibra di carbonio
- Su richiesta attacco per connessione elettrica e USB

- Reinforced frame for public area use
- Flame-retardant polyurethane foam
- Undeformable polyurethane foam of different densities
- Reinforced stitching with carbon fiber support
- Electrical connection and USB upon request

- Structure renforcée pour une utilisation en espace public
- Mousse polyuréthane expansé ignifuge
- Mousse polyuréthane expansé indéformable à épaisseurs différenciées
- Coutures renforcées de fibre de carbone
- Sur demande connection électrique et USB

- Verstärkte Holzstruktur für Nutzung bei öffentlichem Bereich
- Feuerfester Polyurethanschaum
- Formbeständige Polyurethanschaum unterschiedlicher Dichte
- Verstärkte Säume mit Stütz aus Kohlefaser
- Elektrische Verbindung und USB-Anschluss auf Anfrage

Coordinati · Matching items · Produits assortis · Abgestimmte Produkte



NODE+



ACCURSIO



TURI TURI



SCANCARÒ

Finiture tavolo · Table finishes · Finitions de table · Tischausführungen



Avorio  
Ivory  
Ivoire  
Elfenbein



Nero pece  
Pitch black  
Poix noir  
Pech Schwarz

cod. 1411 / armchair with right table

cod. 1412 / armchair with left table

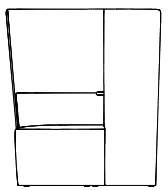

110 cm  
43 1/4"

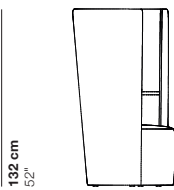

80 cm  
31 1/2"

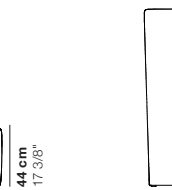

44 cm  
17 3/8"

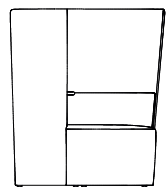

110 cm  
43 1/4"

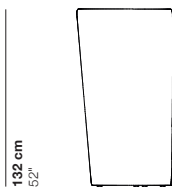

80 cm  
31 1/2"

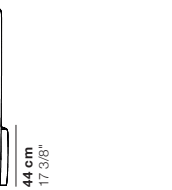

44 cm  
17 3/8"

BORGO

**BORGO** cod. 1430  
Coffee table /  
**BORGO** cod. 1431  
Coffee table

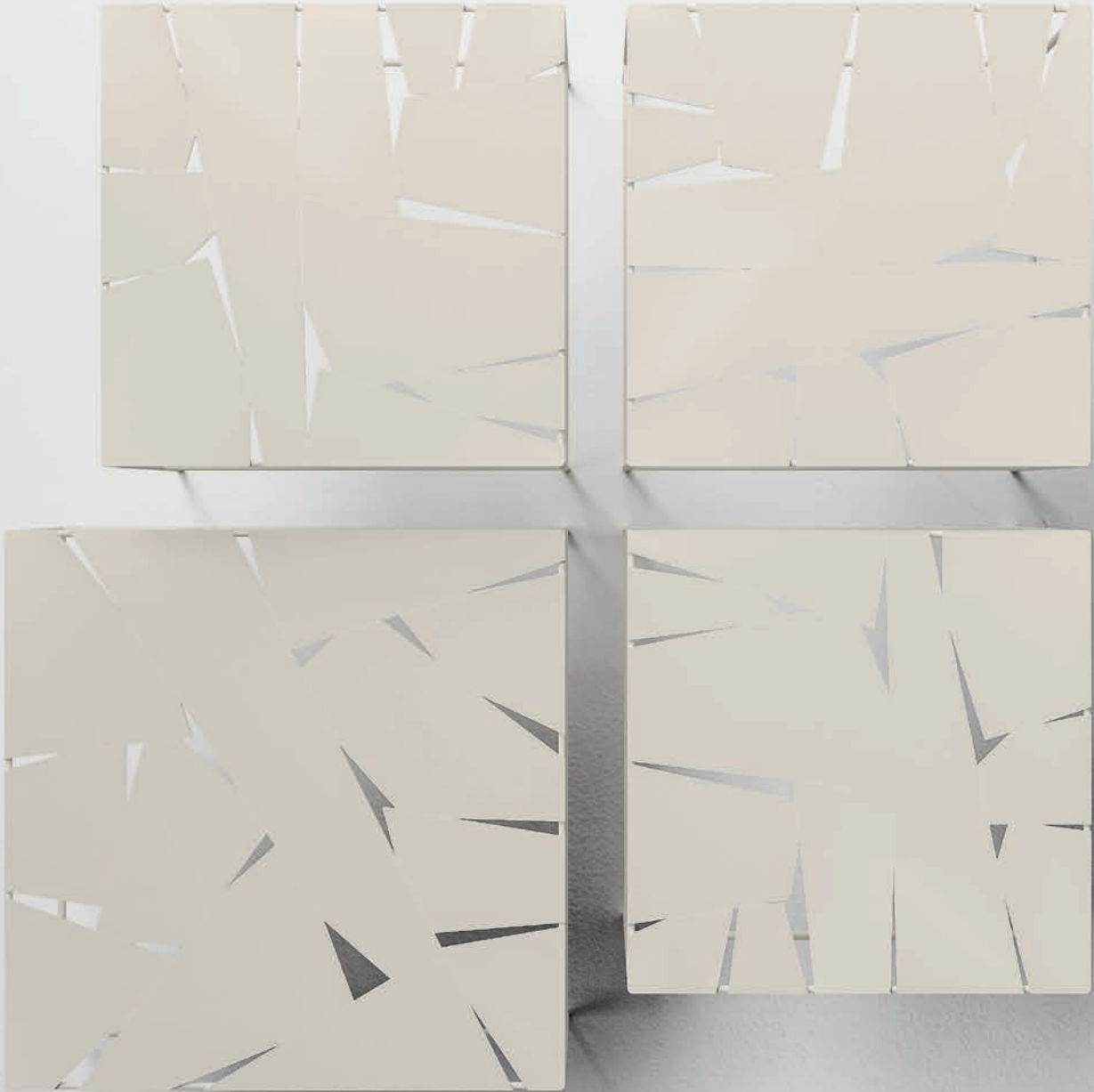

# Borgo

|                 |  |
|-----------------|--|
| <b>Family</b>   | Coffee Table   |
| <b>Designer</b> | Antonino Sciortino / 2022                                      |
| <b>Link</b>     | <a href="http://www.read-mo.re/borgo">www.read-mo.re/borgo</a> |

**IT** Il tavolino Borgo è un foglio in acciaio sul quale sono stati praticati dei tagli irregolari che, collegati tra loro, ricordano le viuzze di un caratteristico paese siciliano. L'ispirazione nasce dal Cretto di Burri, opera di land art che appare come una serie di fratture sul terreno, quando vista dall'alto. Il coffee table Borgo ha una struttura realizzata in tondino d'acciaio, ha una forma quadrata e rettangolare, è disponibile in tre dimensioni. I colori spaziano dal pastello alle finiture speciali in bronzo, ottone e rame.

## EN

The top of the Borgo coffee table is made of sheet steel featuring cuts at irregular intervals that are interconnected and call to mind the narrow streets of a picturesque Sicilian town. The inspiration came from the Cretto di Burri: a landscape artwork that looks like a series of cracks in the ground when viewed from above. The coffee table has a structure made from round steel bars and a rectangular shape. It comes in three different sizes. The colours range from pastel hues to special bronze, brass and copper finishes.

## FR

La table basse Borgo est une feuille d'acier sur laquelle ont été pratiquées des entailles irrégulières qui, une fois reliées, évoquent les ruelles d'un petit village sicilien typique. Le créateur s'est inspiré du Cretto di Burri, une œuvre du land art qui, vue d'en haut, apparaît comme une série de fractures sur le terrain. La table basse Borgo repose sur une structure en tige d'acier, arbore une forme carrée et rectangulaire, et est proposée en trois tailles. La palette de couleurs va du pastel aux finitions spéciales en bronze, laiton et cuivre.

## DE

Der Couchtisch Borgo besteht aus einem Stahlblatt mit unregelmäßigen, miteinander verbundenen Einschnitten, die an die verwinkelten Gassen eines charakteristischen Dorfes auf Sizilien erinnern, und wurde von Alberto Burris' Land-Art-Werk „Cretto“ inspiriert, das aus der Vogelperspektive wie eine von Spalten durchzogene Landschaft erscheint. Der Beistelltisch Borgo hat eine quadratische, rechtwinklige Struktur und ist in drei Größen und verschiedenen Pastellfarben sowie in Spezialausführungen aus Bronze, Messing und Kupfer erhältlich.

BORGO

**BORGO** cod. 1431  
Coffee table /  
**PINCH** cod. 9101  
Armchair



COFFEE TABLE

**BORG** cod. 1430  
Coffee table /  
**BORG** cod. 1431  
Coffee table



BORGO

**BORGO** cod. 1431  
Coffee table





COFFEE TABLE

Dati tecnici · Technical data · Données techniques · Technische Angaben

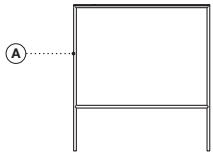

A. Acciaio

A. Acier

A. Steel

A. Stahl

Finiture · Finishes · Finitions · Ausführungen



Avorio  
Ivory  
Ivoire  
Elfenbein



Fango  
Mud  
Boue  
Schlamm



Prugna  
Plum  
Prune  
Pflaume



Cioccolato  
Chocolate  
Chocolat  
Schokolade



Nero pece  
Pitch black  
Poix noir  
Pech Schwarz



Tè verde  
Green tea  
Thé vert  
Grüner Tee



Fiordaliso  
Cornflower  
Bleuet  
Kornblume



Laccato bronzo  
Lacquered bronze  
Laqué bronze  
Bronze lackiert



Laccato ottone  
Lacquered brass  
Laqué laiton  
Messing lackiert



Laccato rame  
Lacquered copper  
Laqué cuivre  
Kupfer lackiert

cod. 1430 / coffee table

cod. 1431 / coffee table

cod. 1432 / coffee table

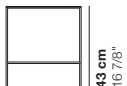

43 cm  
16 7/8"



40 cm  
15 6/8"



35 cm  
13 6/8"



50 cm  
19 5/8"



50 cm  
19 5/8"



65 cm  
25 5/8"

IDDA

**IDDA** cod. 1420  
Coffee table /  
**IDDA** cod. 1421  
Coffee table

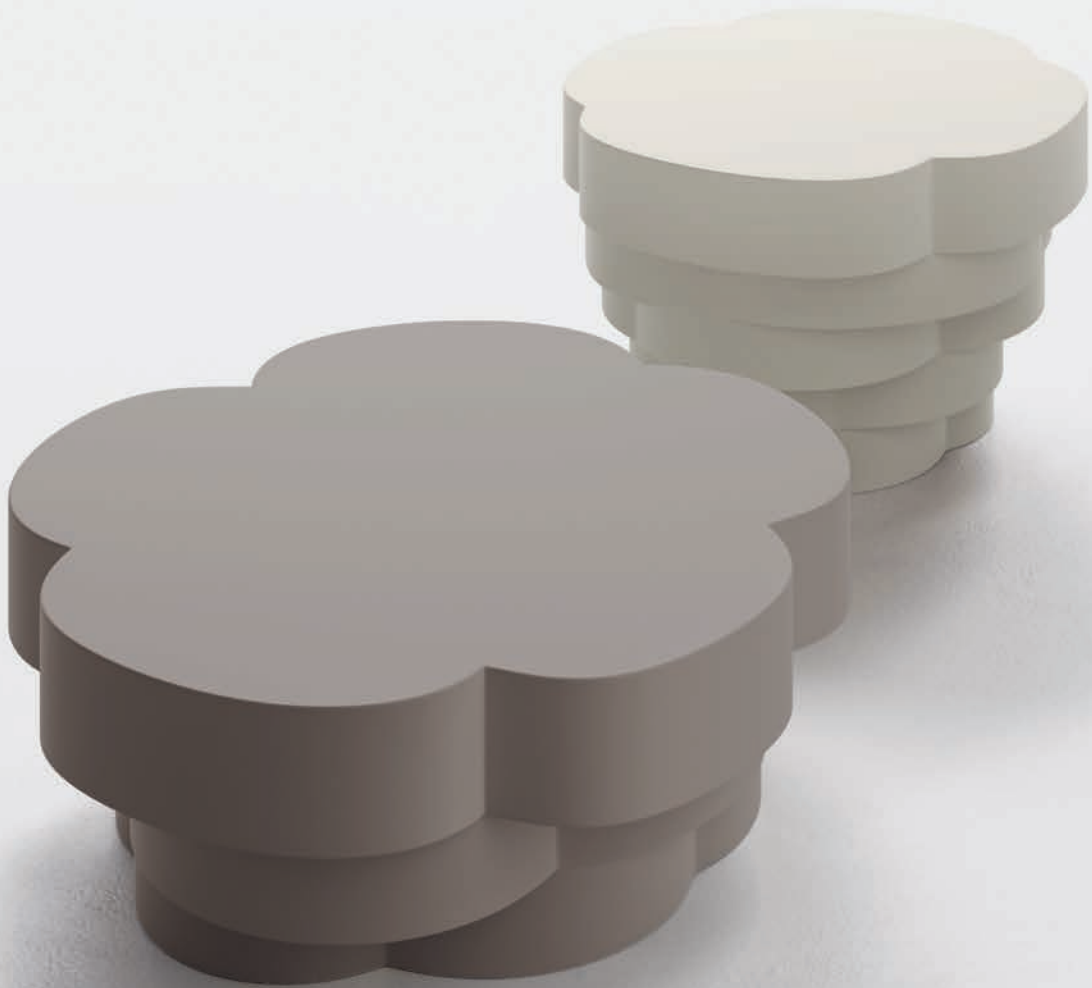

# Idda

---

**Family**

Coffee Table

---

**Designer**

Antonino Sciortino / 2022

---

**Link**
[www.read-mo.re/idda](http://www.read-mo.re/idda)

**IT** Una scultura prestata alla funzione di tavolino, che omaggia la bellezza dell'Etna e delle sue sinuose colate di lava. Idda rievoca la silhouette capovolta del vulcano, attraverso una struttura in lamiera che si fa straordinariamente delicata e armonica. Fasce curvate a mano e di diverse dimensioni si sovrappongono l'una sull'altra, in tre o cinque piani di altezza, dando forma a un coffee table dalle volumetrie piene e naturali.

**EN**

This sculpture serves as a table and pays tribute to the beauty of Mount Etna, with its winding lava flows. Idda's exceptionally delicate and harmonious sheet metal structure takes the outline of the volcano and turns it upside down. Strips of different sizes are bent by hand and placed on top of each other to form three or five layers, creating a coffee table with full, natural shapes.

**FR**

Une sculpture prêtée à la fonction de table basse, qui rend hommage à la beauté de l'Etna et de ses sinueuses coulées de lave. La structure en tôle d'Idda, incroyablement délicate et harmonieuse, évoque la silhouette renversée du volcan. Des bandes incurvées à la main et de différentes tailles se chevauchent sur trois ou cinq niveaux, donnant corps à une table basse aux volumes pleins et naturels.

**DE**

Der Beistelltisch Idda hat die Form einer Skulptur und ist eine Hommage an den eindrucksvollen Ätna und seine sich schlängelnden Lavaströme. Idda beschwört mit ihrer Struktur aus Metallblech die kopfüber stehende Silhouette des Vulkans herauf, die außerordentlich zart und harmonisch wirkt. Die von Hand gebogenen Bänder in unterschiedlichen Größen überlagern sich, bilden drei oder fünf Ebenen und formen einen Couchtisch mit vollem, natürlichem Volumen.

IDDA

**IDDA** cod. 1420  
Coffee table /  
**IDDA** cod. 1421  
Coffee table /  
**SCANCARÒ** cod. 8832  
Coffee table /  
**BORGIO** cod. 1432  
Coffee table /  
**NODE+**  
Sofa composition



COFFEE TABLE



COLLECTION

**IDDA** cod. 1420  
Coffee table /  
**IDDA** cod. 1421  
Coffee table



COFFEE TABLE



**IDDA** cod. 1421  
Coffee table /  
**SUISEKI** cod. SUI03  
Sofa composition

IDDA

**IDDA** cod. 1421  
Coffee table

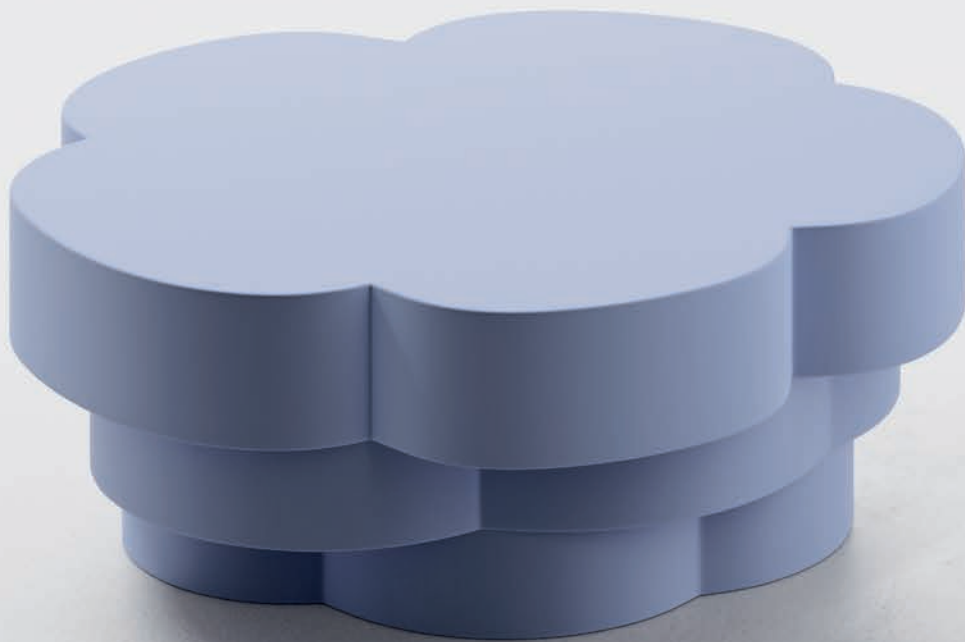



COFFEE TABLE

Dati tecnici · Technical data · Données techniques · Technische Angaben

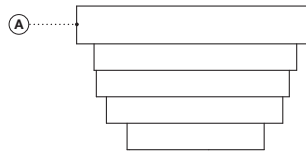

A. Acciaio

A. Acier

A. Steel

A. Stahl

Finiture · Finishes · Finitions · Ausführungen



Avorio  
Ivory  
Ivoire  
Elfenbein



Fango  
Mud  
Boue  
Schlamm



Prugna  
Plum  
Prune  
Pflaume



Cioccolato  
Chocolate  
Chocolat  
Schokolade



Nero pece  
Pitch black  
Poix noir  
Pech Schwarz



Tè verde  
Green tea  
Thé vert  
Grüner Tee



Fiordaliso  
Cornflower  
Bleuet  
Kornblume



Laccato bronzo  
Lacquered bronze  
Laqué bronze  
Bronze lackiert



Laccato ottone  
Lacquered brass  
Laqué laiton  
Messing lackiert



Laccato rame  
Lacquered copper  
Laqué cuivre  
Kupfer lackiert

cod. 1420 / coffee table

cod. 1421 / coffee table

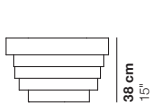

38 cm  
15"

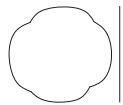

61 cm  
24"

57 cm  
22 1/2"

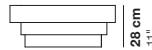

28 cm  
11"



76 cm  
28 7/8"

71 cm  
28"

---

**LaCividina srl**

---

**HEADQUARTERS  
/ PRODUCTION**

Via Spilimbergo 162  
33035 Martignacco  
Udine Italy

T. + 39 0432 677433  
F. + 39 0432 677480  
info@lacividina.com  
www.lacividina.com

**COMPANY SHOWROOM**

Via Lungolavia 1  
33035 Martignacco  
Udine Italy  
T. + 39 0432 677433



---

**Press Office**

---

Carter&Bennett  
pr@carterandbennett.com  
tel. +39 0432 1746101

/ LaCividina s.r.l., al fine di migliorare le caratteristiche tecniche e qualitative della sua produzione, si riserva di apportare, anche senza preavviso, tutte le modifiche che si rendessero necessarie.

/ With a view to improving the technical characteristics and quality of its products, LaCividina s.r.l. reserves the right to develop its products at any time without notice.

/ Afin d'améliorer les caractéristiques techniques et qualitatives de sa production, LaCividina s.r.l. se réserve d'apporter, même sans préavis, toutes les modifications qui se rendront nécessaires.

/ Zur Verbesserung der technischen und qualitativen Merkmale behält sich LaCividina s.r.l. vor, alle notwendig erscheinenden Produktionsänderungen auch ohne Vorankündigung durchzuführen.

---

**Company Art Director**

---

Luca Botto

---

**Graphic Design**

---

Designwork

---

**Photo**

---

Alessandro Paderni / Studio Eye

---

**2D/3D development**

---

Michele Poletto

---

**Render**

---

Nudesign Studio

---

**Copywriting**

---

Carter&Bennett

---

**Made and printed in Italy**

---

Grafiche Manzanesi  
May 2022





**LaCividina srl**

**HEADQUARTERS  
/ PRODUCTION**

Via Spilimbergo 162  
33035 Martignacco  
Udine Italy

T. + 39 0432 677433

F. + 39 0432 677480

info@lacividina.com

www.lacividina.com

**COMPANY SHOWROOM**

Via Lungolavia 1  
33035 Martignacco  
Udine Italy

T. + 39 0432 677433